

We hope you enjoy your



ice cream freezer!

Richmond Cedar pioneered in the manufacture of home Ice Cream Freezers in 1868, and today's models are a fine product of experience and modern technology. You can be assured of years of dependable, care-free service.

It has been carefully finished for permanent "good looks". All workmanship, materials, and parts are of highest quality. If you do enjoy it as much as we believe you will, won't you tell your friends about it, and where you bought it? Your enthusiastic recommendation is our best advertising. We will appreciate this important favor. Thank you.

RICHMOND CEDAR WORKS MGF. CORP.

400 Bridge St., Danville, Virginia 24541

Recipes & Instructions
for
**Homemade
Ice Cream**
and other frozen desserts



Made in your new RCW freezer.

Thank you for buying this RCW Yum-Yum Machine. RCW freezers are the nation's most popular because they make the freezin' fun!

Whether you've just purchased an "old fashioned" hand cranked model, or an effortless electric model, the results will be the same . . . delicious homemade ice cream of unequalled texture and flavor.

This booklet tells you how to operate your RCW freezer and also gives you some delicious tried and proven recipes. So get ready for a treat . . . from basic vanilla to whatever your imagination can create, with an RCW "Yum-Yum" machine, making it is half the fun.

Your ice cream freezer and its parts.

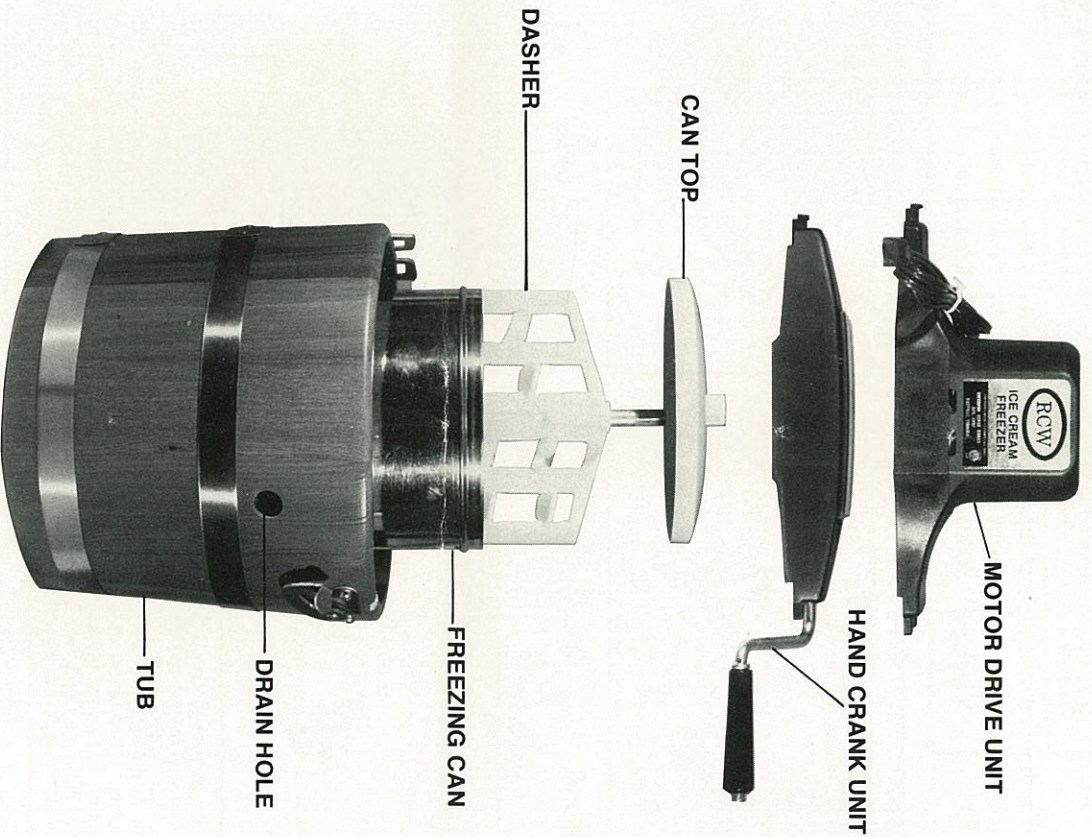

IMPORTANT SAFEGUARDS

When using electrical appliances, basic safety precautions should always be followed including the following:

1. Read all instructions.
2. To protect against electrical hazards do not immerse electric motor in water or other liquid.
3. Close supervision is necessary when any appliance is used by or near children.
4. Unplug from outlet when not in use, before putting on or taking off parts, and before cleaning.
5. Avoid contacting moving parts.
6. Do not operate any appliance with a damaged cord or plug or after the appliance malfunctions, or is dropped or damaged in any manner. Return appliance to Freezer Parts Supply, P. O. Box 3431, Danville, Va. 24541, for examination, repair or adjustment.
7. The use of attachments not recommended by the appliance manufacturer may cause hazards.
8. Do not use outdoors.
9. Do not let cord hang over edge of table or counter or touch hot surfaces.

SAVE THESE INSTRUCTIONS

CARE OF FREEZER WHEN NOT IN USE.

After using your freezer, wash and dry can, can top and dasher thoroughly. Be sure can is dry before replacing can top. Do not put plastic parts in dishwasher. Wipe motor or crank and pail with a dry cloth after each use. Do not immerse electric motor in water. Do not oil motor as this was done at factory. Store freezer in a cool dry place. Take care of your freezer and it will give you many years of trouble-free service.

OPERATING INSTRUCTIONS

Read all instructions before starting to make ice cream.

ICE AND SALT (ROCK OR TABLESALT) NEEDED FOR MAKING, HARDENING AND RIPENING ICE CREAM						
Size of Freezer	Ice for Making Ice Cream	Ice for Hardening and Ripening Ice Cream	Rock Salt For Making Ice Cream	Rock Salt for Hardening and Ripening Ice Cream	Tablesalt for Making Ice Cream	Tablesalt for Ripening Ice Cream
4 qts.	15 lbs. crushed ice	5 lbs. crushed ice	2½ cups	2½ cups	1½ cups	1½ cups
5 qts.	10 lbs. crushed ice	5 lbs. crushed ice	2 cups	2 cups	1½ cups	1½ cups
6 qts.	20 lbs. crushed ice	5 lbs. crushed ice	3 cups	3 cups	2 cups	2 cups

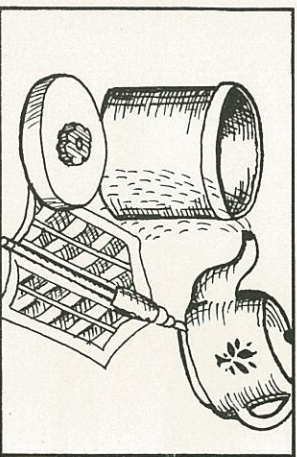

1 Thoroughly wash the beater, lid and cream can before using. Let the parts cool before using, as you will get much faster freezing if your cream is parts are cold.

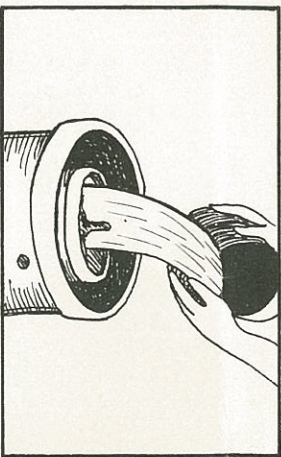

2 Insert dasher in can, making sure it is set securely in bottom of can. Pour in mixture to be frozen, made from your favorite recipe or one of the delicious recipes shown in this booklet. The mixture should be cool before pouring in can for faster, more even freezing. Fill the can only two-thirds full (up to fill line stamped on can), to allow for expansion!

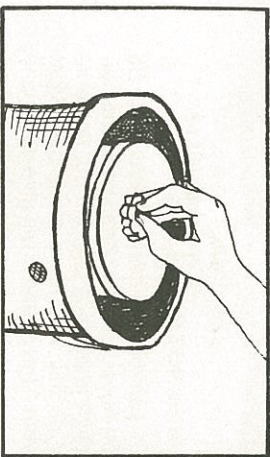

3 Put lid on can and place can in freezer, making certain that can is centered on can rest in bottom of pail.

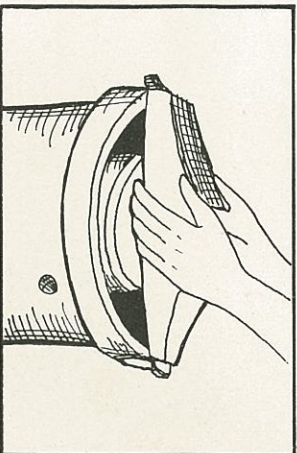

4 Attach motor unit (cranking mechanism if hand operated) making sure dasher is still positioned properly in can and can is still on bottom rest in pail. Latch down securely.

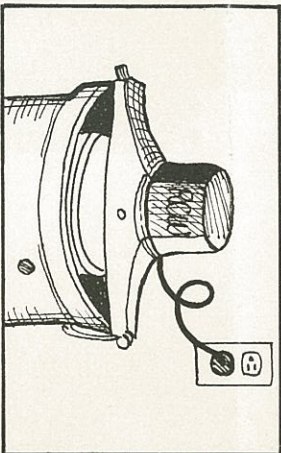

5 Plug motor in on electric models before packing ice and salt. (Step 6). The can will begin to turn steadily to the right. On hand operated models, you start cranking as soon as tub is packed. Turn crank steadily to the right (avoid turning left), not too fast. **NOTE: The dasher is not designed to turn. It remains stationary, and the can revolves around it.**

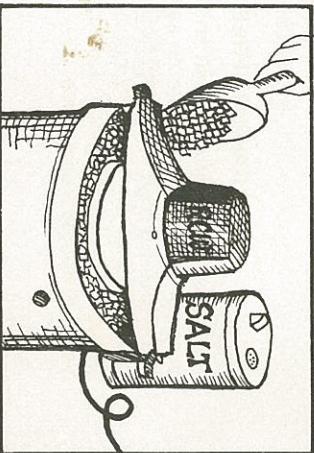

6 Packing ice and salt—Use either crushed ice cubes or crushed store bought ice. (The finer the ice is crushed the better it is, as the freezer is designed to operate with crushed ice. Also, finely crushed ice will melt more evenly and will therefore give you a smoother textured ice cream.) In packing, put about three inches of ice in tub all around can and sprinkle about 2½ oz. of table salt or 4 oz. of rock salt, evenly over ice. Continue adding ice and salt (in the above proportions) layer by layer, until tub is filled up to but not over top of can. After tub is filled, we suggest you add one cup of cold water to the ice and salt mixture. This will help the ice to melt and settle, which will shorten freezing time, and will help keep ice from jamming and causing nuisance stops. As the ice melts and settles, it will be necessary to add more ice and salt as needed to keep it up to but **not over top of can**. Before the cream is finished, the ice will melt enough to cause water to flow from the drain hole. Never let this drain hole become stopped up with ice. (The cork supplied is **not for this drain hole**. It is for the can top, as described in step 8.) **CAUTION: Do not allow ice, salt, or water to get in air holes at base or top of motor housing, as this will cause the motor to corrode.**

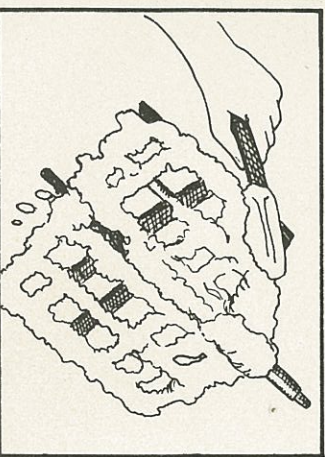

7 Electric—The motor should run for about 20-30 minutes, or until it stops, at which time it should be unplugged. The motor is equipped with an automatic reset device, which will prevent motor damage when it naturally stops when cream is ready, or if for some reason it stops prematurely before cream is ready. If the freezer stops and the motor is not unplugged, the motor will automatically cut off and will stay off until it cools down. It will

continue to automatically cut off and on until the motor is unplugged. This on/off action will not cause any damage to the motor. Note: Freezer may become clogged with chunks of cracked ice, which can cause unit to stall prematurely before cream is made. If this happens, simply restart unit by turning can with hands. **Hand Operated**—The freezing period should take about 20 minutes of steady cranking. After freezer turns reasonably hard, the cream is ready. At this point, continuing to turn is not necessary. (See step 8.) After cream is ready, remove motor (cranking mechanism if hand operated). Wipe all ice and salt from lid and then remove the lid. Hold can down on bottom rest while taking out dasher. The ice cream should be about the consistency of mush. Scrape the cream from dasher and pack down with long handled spoon. (If you wish to ripen or harden the ice cream further, see step 8.)

NOTE: If you have RCWS'S 5 quart freezer, the can is designed to fit into most refrigerator freezer compartments, and you may eliminate step 8 below if you wish, and harden the cream right in your refrigerator freezing compartment.

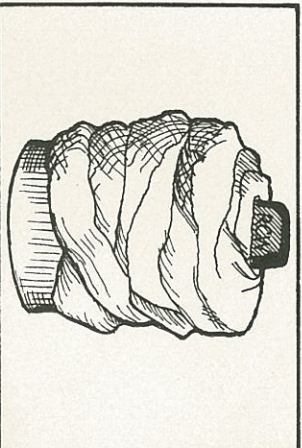

8 Ripening and hardening ice cream—After the cream has been packed down, place the cork in can top and put can top back on freezer. Repack freezer (allowing water to remain in tub up to drain hole), with more ice and salt (approximately 2½ oz. of table salt or 4 oz. of rock salt), to every two double handfuls of ice), until can and lid are completely covered. Cover freezer with heavy towel or newspaper and set away in a cool place until time to serve. The cream will now freeze hard. If you want to hold the cream for more than an hour before using, add more ice and salt (in above proportions) as needed.

Hints For Making Better Ice Cream

Consistency of ice cream may vary from batch to batch. Several factors that affect the firmness or consistency of ice cream are: recipe used, outside temperatures, size of ice, temperature of brine and temperature of mixture before it is churned.

TOO SOFT

If the motor continues to run freely after 30 minutes, the brine is not cold enough, therefore the cream is not hardening. You should now add another ½ cup of table salt or ½ cup of rock salt. This will begin to reduce the brine temperature and cause the cream to harden. As the ice melts, you may have to continue to add ice and salt as outlined in our instructions, until the motor goes into its intended stall.

RCW RECIPES

VANILLA CREAM (Basic Recipe)

2 cups milk
1 cup sugar
4 Tablespoons vanilla

¼ teaspoon salt
4 cups of light or table cream
2 Tablespoons vanilla

Scald milk. Add the sugar and salt to the milk and stir until both are thoroughly dissolved. Add the cream. Stir in the vanilla. Cool. Turn into freezer. Makes approx. 2 quarts.

TOO GRAINY, ICY OR HARD

If the motor stalls, in less than 20 minutes, resulting in coarse or an inconsistent texture of ice cream the brine became too cold too fast. In this case, you used too much salt and the cream froze too fast on the edge of the can, and/or you failed to use crushed ice.

RECIPE HINTS

Preparing the ice cream mixture the day before makes smoother ice cream and increases the yield.

ELECTRIC FREEZING

Electric Freezing takes longer than hand operated. You will get better results with your electric freezer by using ¼ less salt.

VANILLA ICE CREAM (No Cooking)

4 eggs
1 cup sugar
2 Tablespoons vanilla
½ pint whipping cream

2 cans condensed milk (Eagle Brand) Dairy Milk (approx. 1½ quarts)
¼ teaspoon salt

Combine eggs, cream, sugar, salt and vanilla in bowl and mix thoroughly with mixer. Pour into can, add condensed milk and stir well. Add dairy milk to fill line on can and stir. Makes approx. 4 quarts.

LOW CALORIE VANILLA ICE CREAM

6 eggs
5 cups milk
12 Saccharin tablets (½ grain) or 4 Tablespoons liquid sweetener

6½ cups half and half
3 Tablespoons plain gelatin
4 Tablespoons vanilla
¼ Teaspoon salt

Make a custard of the eggs, milk and liquid sweetener. Soak the gelatin in a small amount of water, and add enough hot custard to dissolve the gelatin. Cool. Add cream, vanilla, salt and gelatin to custard. Strain and freeze. This will still be palatable and contain even fewer calories if all of the milk and half and half are replaced by non-fat milk. Makes approx. 4 quarts.

VANILLA ICE CREAM (Philadelphia)

No Cooking!
1 quart thin cream (Half and Half)
Thoroughly mix all ingredients, then freeze. Makes approx. 1½ quarts.

COUNTRY STYLE VANILLA

4 eggs
Approx. 5 cups milk
2 Tablespoons vanilla

2½ cups sugar
4 cups whipping cream
¼ Teaspoon salt

In a large mixing bowl beat eggs until foamy. Gradually add sugar. Beat until thickened. Add cream, vanilla and salt and mix thoroughly. Pour into can. Add milk to fill line on can and stir well. Freeze as directed. Makes approx. 4 quarts.

BASIC VANILLA FROZEN YOGURT

20 oz. plain yogurt
½ cup sugar
1 envelope unflavored gelatin

dash of salt
½ cup evaporated milk
2 teaspoons vanilla softened in ¼ cup water

Scald evaporated milk over low heat stirring occasionally to avoid the "skin" formation over the top of the milk. Add sugar, salt and softened gelatin. Stir until thoroughly dissolved and mixture is completely smooth. Cool, add yogurt and vanilla. Mix well. Chill thoroughly in refrigerator for 2 hours or longer. Pour into can and freeze. Makes approx. 2 quarts.

FRUIT ICE CREAM

Vanilla recipes may be varied with the addition of either good ripe peaches, bananas, strawberries, or most any other fruits or flavors one may desire. (We suggest one cup of presweetened fruit per quart of ice cream.)

CHOCOLATE ICE CREAM

1 cup sugar
5 cups evaporated milk
2 squares chocolate

1½ teaspoons vanilla
¼ teaspoon salt

Scald the milk. Dissolve the sugar in two cups of the scalded milk. Pour sugar and milk mixture slowly over melted chocolate, stir constantly to avoid dark specks. Add the remaining three cups of milk. Stir in the vanilla and salt. Freeze. Makes approx. 2 quarts.

COFFEE ICE CREAM

Combine ¼ cup powdered instant coffee with the sugar in the basic vanilla recipe. Prepare and freeze per recipe.

USING RCW'S ICE CREAM BASE

For your convenience, RCW distributes an ice cream base which is packaged in 8 oz. pouches and makes 2 quarts of good home style ice cream when mixed with 2 pints of Half & Half. You simply add flavors or fresh fruit to your taste. Complete recipes and instructions are included on each package. This is available at many retail outlets.

PEPPERMINT CANDY ICE CREAM

Add 1½ cups crushed peppermint stick candy to any vanilla cream recipe after it has frozen until it is mushy (about 15 minutes of freezing). Continue freezing as directed. Makes approx. 2 quarts.

CHOCOLATE CHIP ICE CREAM

Grate or chop semi-sweet chocolate to make 1½ cups. Add to vanilla ice cream recipe after it has frozen until it is mushy or about 15 minutes. Continue freezing as directed. Makes approx. 2 quarts.

"PEACH-APRICOT DELIGHT"

2 large cans evaporated milk
1 small can apricot nectar (12 oz.)
4 or 5 fresh soft peaches mashed fine (or 1 large can peaches, drained and mashed)
Dairy milk to fill up to two thirds of cream can.

FROZEN CUSTARD

2 cups milk
3 egg yolks
1 cup sugar

¾ teaspoon salt
2 cups light or table cream
4 teaspoons vanilla

Scald milk in a double boiler. Beat egg yolks, sugar and salt. Pour scalded milk over beaten mixture. Return to double boiler and cook until it coats a spoon. Allow mixture to cool. Add the cream and vanilla and freeze. Makes approx. 2 quarts.

LEMON SHERBET

2 cups sugar
juice of 6 lemons
juice of 2 oranges

1 quart light or table cream
4 egg whites

Chill the lemon and orange juice and sugar in the freezer. Add the milk and cream. Fold in the stiffly beaten egg whites. Freeze. Makes approx. 3 quarts.

LIME SHERBET

1½ cups sugar
1½ cups water
¼ teaspoon salt

4 cups light or table cream
1 cup lime juice
1 teaspoon vanilla

Boil the sugar and water together until it forms a thick syrup. Add the salt. Allow the mixture to cool. Add cream, lime juice and vanilla. Freeze. Makes approx. 3 quarts.

ORANGE ICE

4 cups water
grated rind of 2 oranges

2 cups sugar
2 cups orange juice
¼ cup lemon juice

Boil sugar and water 5 minutes. Add fruit juices and rind. Cool, strain and freeze. Makes approx. 2 quarts.

COFFEE PARFAIT

2 Tablespoons cornstarch
½ cup sugar
1 cup strong coffee

2 Tablespoons milk
2 egg yolks
½ teaspoon salt
1½ cups heavy cream

USING HONEY

Honey may be substituted for sugar in most all recipes contained in this booklet. Experiment until you find the flavor you like best. Substitute ½ cup of honey for every 1 cup of sugar and follow recipe instructions. When using honey, it takes a little longer for the cream to freeze. Therefore, you will need to use a slightly greater proportion of salt to ice to freeze the cream.

